

en 02-2013/01 50121262 068-14515



12mm ... 32mm



- Scanner for color detection
- Simultaneous selection of up to 3 colors
- Detection independent of distance
- Teach-in via buttons or control line
- Temperature compensation
- Other special functions

Dimensioned drawing

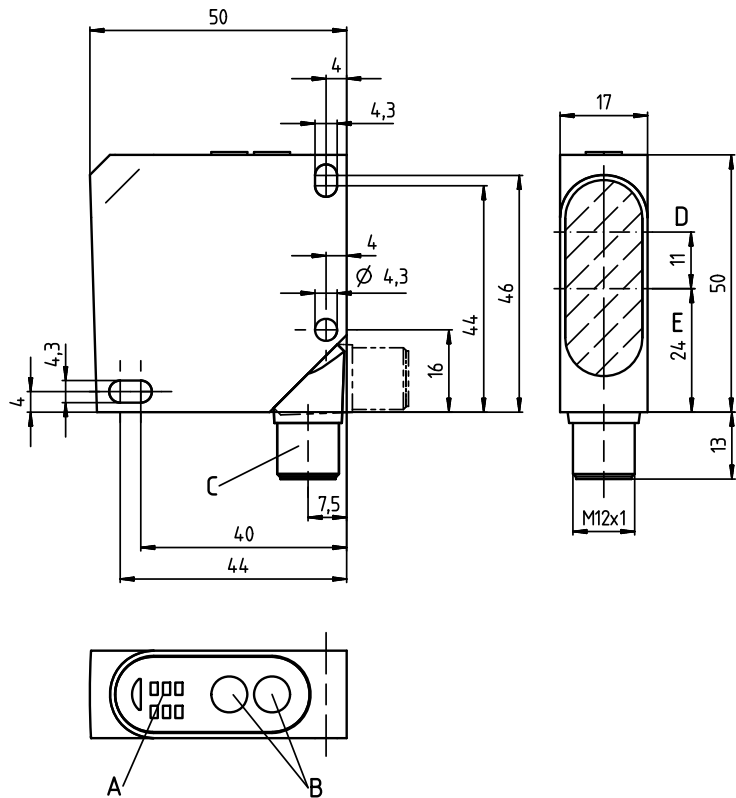

- A Display
- B Configuration
- C Turning connector
- D Transmitter
- E Receiver

Electrical connection

CRT448.S3/444-M12  
CRT448.L3/444-M12

CRT448.S3/222-M12  
CRT448.L3/222-M12

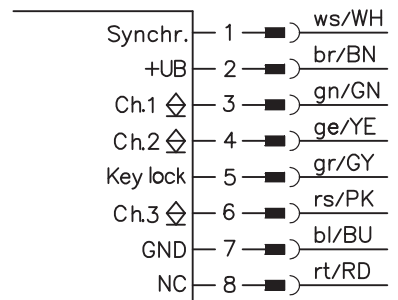
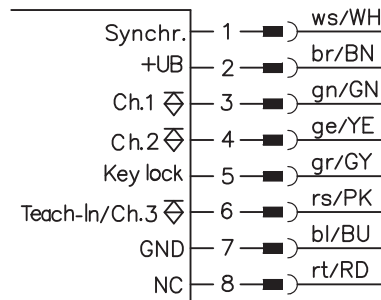

Accessories:

(available separately)

- Cable with M12 connector, 8-pin
- Reflectors

We reserve the right to make changes • DS\_CRT448\_en\_50121262.fm



**Specifications**

**Optical data**

Scanning range (see remarks)  
 Light spot dimensions (in scanning range)  
 Operating range with reflector <sup>1)</sup>  
 Light spot orientation  
 Light source<sup>2)</sup>

**S light spot**

12 mm ... 32 mm  
 round=4.0mm  
 50 ... 200mm

**L light spot**

18mm ... 22mm  
 1 mm x 5mm

vertical

LED, white

**Timing**

Switching frequency <sup>3)</sup>  
 Response time <sup>3)</sup>  
 Delay before start-up  
 Storage time for teach values

500Hz  
 1 ms  
 ≤ 500ms  
 ≤ 50ms, non-volatile storage

**Electrical data**

Operating voltage  $U_B$   
 Residual ripple<sup>4)</sup>  
 Switching output  
 Function characteristics  
 Signal voltage high/low

12 ... 28VDC  
 ≤ 10% of  $U_B$   
 3x PNP or 3x NPN  
 light switching for all outputs  
 PNP:  $\geq (U_B - 3 V/0V)$   
 NPN:  $U_B \leq 3V$   
 max. 100mA per output  
 ≤ 40mA

Output current  
 Open-circuit current

**Indicators**

LED green

Ch.-LED(s) yellow  
 Tol.-LED(s) red

ON: ready  
 OFF: teach event active  
 Ch. 1 ... Ch. 3: object 1 ... 3 detected  
 tolerance level 1 ... 5

**Mechanical data**

Housing  
 Optics cover  
 Weight  
 Connection type

ABS plastic  
 PMMA  
 40g  
 M12 connector, 8-pin

**Environmental data**

Ambient temp. (operation/storage)  
 Protection class  
 Eye safety  
 VDE safety class <sup>5)</sup>  
 Protective circuit <sup>6)</sup>  
 Standards applied  
 Certifications

-10°C ... +55°C / -20°C ... +70°C  
 IP 67  
 in acc. with EN 62471: exempt group II, all-insulated  
 2, 3  
 IEC 60947-5-2  
 UL 508 <sup>7)</sup>

**Options**

**Synchronous input**

PNP: Stop/Start measurement  
 NPN: Stop/Start measurement  
 Synchronization delay

> 12V ... 28V/0V or not connected  
 > 12V ... 28V/0V or not connected  
 < 2ms

**Key lock input**

PNP: lock / unlock  
 NPN: lock / unlock  
 Delay

> 12V ... 28V/0V or not connected  
 > 12V ... 28V/0V or not connected  
 < 2ms

- 1) With reflector TKS 100x100
- 2) Average life expectancy 100,000h at an ambient temperature of 25°C
- 3) With light-dark ratio 1:1
- 4) Must lie within  $U_B \pm$  tolerance
- 5) Rating voltage 50VDC
- 6) 2=polarity reversal protection, 3=short circuit protection for all outputs
- 7) For UL applications: for use in class 2 circuits according to NEC only

**Order guide**

See section **Preferred types**

**Diagrams**

**Synchronous input**

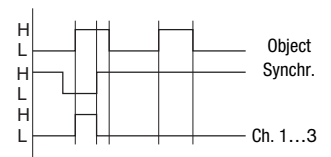

**Reflector operation for transparent objects**

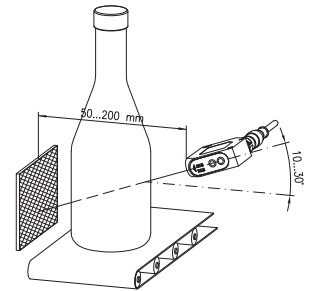

**Typ. color resolution for remissions >20%**

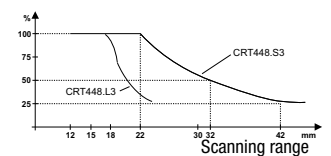

**Remarks**

- **Approved purpose:**  
 The CRT448 color sensors are optoelectronic sensors and are used for optical, contactless detection of colored objects with incident light (scanner operation) and transmitted light (reflector operation). A reflector is necessary for operation in transmitted light.
- With shiny objects, the sensor is to be mounted at an angle of approx. 10 ... 30° to the object surface.

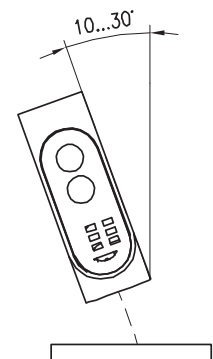

### Function principle of the color sensor

Many sensors are capable of differentiating between light and dark or matt and shiny. As soon as color is to serve as a distinguishing criterion, however, normal sensors are quickly pushed to their limits.

As a result, color sensors are of increasing importance in industrial automation.

The applications range from sorting colored objects to the detection or inspection of colored surfaces. Materials such as powders, granulates, fluids as well as metals, glasses, papers, plastics and textiles can be reliably detected in this way.

Simple operation makes it possible to teach-in individual reference colors and reference color gradients as well as adjust the tolerance bands.

During operation, the color sensor compares the taught-in color with the measured color. If the values lie within the set tolerance range, the sensor passes on the match to the controller via a switching output.

### Controls and indicators

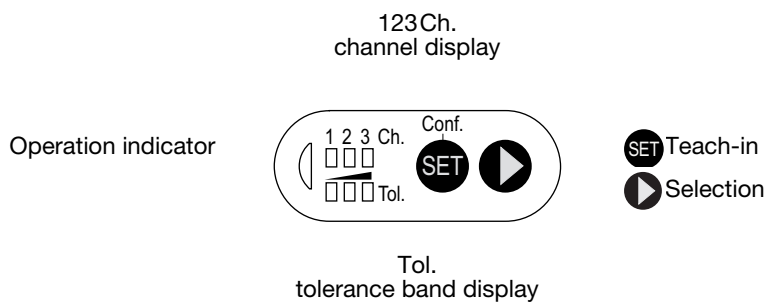

### Operation

During operation, the assignment of the detected color to the switching output is shown via the 123ch. display. In normal mode, only one of these LEDs should be illuminated, otherwise the tolerance bands of the individual colors should be changed.

Channel/switching output assignment

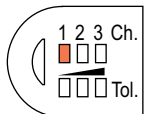
|   |  |
|---|--|
|  | <p>The detected color is assigned to switching output 1.</p> |
|---|--|

Tolerance band assignment

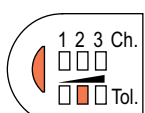
|   |   |
|---|---|
|  | <p>The assignment of the tolerance band is only displayed in teach-in mode.</p> |
|---|---|

### Teach-in of the switching outputs and tolerance band

| ■ = LED ON |                               | Teaching in multiple colors (normal mode)   |                      |   |   |  |             |  |                      |  |             |  |                     |  |                               |
|------------|-------------------------------|---|----------------------|---|---|--|-------------|--|----------------------|--|-------------|--|---------------------|--|-------------------------------|
|            |                               | <p><b>1. Start setting mode + teach in color</b><br/>Position object to be detected within the scanning range (make sure it is tipped 10-30°).<br/><b>Press SET BUTTON for ≥ 3s</b> &gt;&gt; green LED goes out and Ch. 1 illuminates yellow (locking input open or 0 volt).</p>  |                      |   |   |  |             |  |                      |  |             |  |                     |  |                               |
|            |                               | <p><b>2. Select channel</b><br/>With , select one of the color channels (Ch. 1, Ch. 2 or Ch. 3).<br/>The selected channel is indicated with a corresponding yellow LED.<br/>Do <u>not</u> select position Ch. 1+Ch. 2+Ch. 3 (i.e. all three yellow LEDs <u>cannot</u> illuminate at the same time).</p>   |                      |   |   |  |             |  |                      |  |             |  |                     |  |                               |
|            |                               | <p><b>3. Confirm channel</b><br/><b>Confirm the selected color channel with the SET BUTTON (press for ≥ 3s) &gt;&gt; green LED and middle red LED illuminate.</b><br/>Factory setting = Tol. 3 graphic shows the factory setting. If the color differences are large, a high tolerance level should be chosen; for small color differences, a low tolerance level makes sense.</p>  |                      |   |   |  |             |  |                      |  |             |  |                     |  |                               |
|            |                               | <p><b>4. Select tolerance level</b><br/>With , select one of the five tolerance levels.</p>   |                      |   |   |  |             |  |                      |  |             |  |                     |  |                               |
|            |                               | <table border="1"> <tr> <td></td> <td>Tolerance 1 (small)</td> <td rowspan="6"> <p>The green LED is an orientation aid. If the green LED does not illuminate, the tolerance level is too small; it must be increased until the green LED illuminates.</p> </td> </tr> <tr> <td></td> <td>Tolerance 2</td> </tr> <tr> <td></td> <td>Tolerance 3 (medium)</td> </tr> <tr> <td></td> <td>Tolerance 4</td> </tr> <tr> <td></td> <td>Tolerance 5 (large)</td> </tr> <tr> <td></td> <td>Color channel is switched off</td> </tr> </table> |                      | Tolerance 1 (small)   | <p>The green LED is an orientation aid. If the green LED does not illuminate, the tolerance level is too small; it must be increased until the green LED illuminates.</p> |  | Tolerance 2 |  | Tolerance 3 (medium) |  | Tolerance 4 |  | Tolerance 5 (large) |  | Color channel is switched off |
|            |                               |   | Tolerance 1 (small)  | <p>The green LED is an orientation aid. If the green LED does not illuminate, the tolerance level is too small; it must be increased until the green LED illuminates.</p> |   |  |             |  |                      |  |             |  |                     |  |                               |
|            |                               |   | Tolerance 2          |   |   |  |             |  |                      |  |             |  |                     |  |                               |
|            |                               |   | Tolerance 3 (medium) |   |   |  |             |  |                      |  |             |  |                     |  |                               |
|            |                               |   | Tolerance 4          |   |   |  |             |  |                      |  |             |  |                     |  |                               |
|            |                               |   | Tolerance 5 (large)  |   |   |  |             |  |                      |  |             |  |                     |  |                               |
|            | Color channel is switched off |   |                      |   |   |  |             |  |                      |  |             |  |                     |  |                               |
|            |                               | Renewed programming results in reactivation.  |                      |   |   |  |             |  |                      |  |             |  |                     |  |                               |
|            |                               |   |                      |   |   |  |             |  |                      |  |             |  |                     |  |                               |
|            |                               |   |                      |   |   |  |             |  |                      |  |             |  |                     |  |                               |
|            |                               |   |                      |   |   |  |             |  |                      |  |             |  |                     |  |                               |
|            |                               | <p><b>5. Exit setting mode</b><br/><b>Press SET BUTTON for ≥ 3s to confirm tolerance selection.</b><br/>&gt;&gt; <b>The sensor is ready</b> (green LED illuminates; taught Ch. X may also illuminate).<br/>Set all three channels one after another in this way.</p>  |                      |   |   |  |             |  |                      |  |             |  |                     |  |                               |

**Notice on determining tolerance level:**

After an object has been taught, e.g. with Tol. 2, move this object manually within the different distances or positions occurring in the application, and test for error-free function by checking if the yellow LED of the corresponding output channel is illuminated. If an object is not reliably detected, select the next-highest tolerance level. By repeating this process, the optimal tolerance level can be determined.















## Teach-in of color gradients

|  |
|--|
| <p><b>1. Start setting mode</b><br/>                 Position object to be detected within the scanning range (make sure it is tipped 10-30°).<br/> <b>Press SET BUTTON for ≥ 3s</b> &gt;&gt; green LED goes out and Ch. 1 illuminates yellow (locking input open or 0 volt).</p>  |
| <p><b>2. Select color scan function</b><br/>                 With , select one of the color channels (Ch. 1, Ch. 2 or Ch. 3).<br/>                 (Do <u>not</u> select position Ch. 1+Ch. 2+Ch. 3).</p>   |
| <p><b>3. Scan color range + exit setting mode</b><br/> <b>Press SET BUTTON and hold it down, green LED blinks after 10s.</b><br/>                 The color scan function is active. The sensor now permanently learns the colors which it "sees", provided the <u>SET BUTTON remains pressed</u>. By moving the detected object, all colors are scanned which occur on the white light spot of the sensor.<br/> <b>Release SET BUTTON to end the scanning process.</b><br/>                 The sensor is immediately ready to use again.<br/> <b>Function test by checking if yellow LED of the assigned output channel illuminates.</b></p> |

### Notice on color scan:

The color scan serves to teach in entire color gradients or to teach in objects with strongly fluctuating scanning ranges which cannot be detected with a tolerance level. To scan in color gradients of different objects, one object can be scanned in per channel. By connecting the output channels via an OR function in the downstream control, color gradients of up to three different objects can be represented as a color scan.

## Special function

| <p><b>1. Start setting mode</b><br/> <b>Press SET BUTTON for ≥ 3s</b> &gt;&gt; green LED goes out and Ch. 1 illuminates yellow.<br/>                 (Locking input open or &lt; 3 volt).</p>   |                          |                          |   |             |   |                       |   |                     |   |                  |   |
|---|--------------------------|--------------------------|---|-------------|---|-----------------------|---|---------------------|---|------------------|---|
| <p><b>2. Select special function</b><br/>                 With , select position Ch. 1+Ch. 2+Ch. 3. (all three LEDs illuminate).</p>   |                          |                          |   |             |   |                       |   |                     |   |                  |   |
| <p><b>3. Confirm selection</b><br/> <b>With SET BUTTON (press for ≥3s), confirm setting</b> &gt;&gt; first red LED (Tol. 1) illuminates.</p>  |                          |                          |   |             |   |                       |   |                     |   |                  |   |
| <p><b>4. Select special function</b><br/>                 With , select the desired special function.</p>  |                          |                          |   |             |   |                       |   |                     |   |                  |   |
| <p><b>Notices on special functions</b></p>  |                          |                          |   |             |   |                       |   |                     |   |                  |   |
| <table border="1"> <thead> <tr> <th>Tol. display</th> <th>Function characteristics</th> </tr> </thead> <tbody> <tr> <td></td> <td>Output menu</td> </tr> <tr> <td></td> <td>50ms pulse stretching</td> </tr> <tr> <td></td> <td>External teach-in *</td> </tr> <tr> <td></td> <td>Factory settings</td> </tr> </tbody> </table> | Tol. display             | Function characteristics |  | Output menu |  | 50ms pulse stretching |  | External teach-in * |  | Factory settings | <p><b>a. Pulse stretching 50ms</b><br/>                 Extension of the switching signals to 50ms. Acts on all three outputs.</p> <p><b>b. External teach-in *</b><br/>                 Output Q3 becomes a teach-in input. When the HIGH signal is present, a new color with tolerance 3 is taught on channel 1. An acknowledgement signal (50ms) is output at output Q2 after a successful external teach-in.</p> <p><b>c. Factory settings</b><br/>                 Resetting to factory settings. All special functions are deactivated.</p> <p>* only available for PNP types</p> |
| Tol. display  | Function characteristics |                          |   |             |   |                       |   |                     |   |                  |   |
|    | Output menu              |                          |   |             |   |                       |   |                     |   |                  |   |
|    | 50ms pulse stretching    |                          |   |             |   |                       |   |                     |   |                  |   |
|    | External teach-in *      |                          |   |             |   |                       |   |                     |   |                  |   |
|    | Factory settings         |                          |   |             |   |                       |   |                     |   |                  |   |
| <p><b>5. Confirm selection</b><br/>                 Press SET BUTTON (for ≥ 3s) to confirm the selected special functions. (For testing purposes: the selected special function is indicated by the illuminated green LED).</p>   |                          |                          |   |             |   |                       |   |                     |   |                  |   |
| <p><b>6. Delete display</b><br/>                 Press  until all red LEDs go out.</p>   |                          |                          |   |             |   |                       |   |                     |   |                  |   |
| <p><b>7. Exit setting mode</b><br/> <b>Press SET BUTTON (for ≥ 3s)</b> &gt;&gt; green LED illuminates.<br/>                 The sensor is ready in the new operating mode.</p>  |                          |                          |   |             |   |                       |   |                     |   |                  |   |

**Preferred types**

| Selection table    |                              | Order code → | CRT 448.S3/444-M12<br>Part no. 50121294 | CRT 448.L3/444-M12<br>Part no. 50121292 | CRT 448.S3/222-M12<br>Part no. 50121293 | CRT 448.L3/222-M12<br>Part no. 50121291 |
|--------------------|------------------------------|--------------|---|---|---|---|
| Equipment ↓        |                              |              |   |   |   |   |
| Scanning range     | 12 mm ... 32 mm              | ●            |   |   | ●                                       |   |
|                    | 18 mm ... 22 mm              |              |   | ●                                       |   | ●                                       |
| Light-spot profile | S-profile (round, D=4 mm)    | ●            |   |   | ●                                       |   |
|                    | L-profile (1 mm x 5 mm)      |              |   | ●                                       |   | ●                                       |
| Switching output   | 3x PNP                       | ●            | ●                                       |   |   |   |
|                    | 3x NPN                       |              |   | ●                                       | ●                                       |   |
| Configuration      | Teach-in via control buttons | ●            | ●                                       | ●                                       | ●                                       |   |
| Options            | Synchronization              | ●            | ●                                       | ●                                       | ●                                       |   |
|                    | 50 ms pulse stretching       | ●            | ●                                       | ●                                       | ●                                       |   |
|                    | Teach-in via cable           | ●            | ●                                       |   |   |   |

Additional types on request